



**KEY FEATURES**

- Available with 30° (narrow) or 100° (wide) optics
- Designed for Hazardous locations
- IP66/67 GORE vented enclosure
- Easy field angle adjustment
- Lifespan up to 100,000 hours\*
- Available in multiple lengths and a variety of LED colours



**MODEL NUMBER SELECTOR**

Example: GSLEDIP12-CW-W-BLK-C1D2-24VDC-IP66

MODEL	COLOUR	OPTIC	FINISH	LOCATION	POWER	INGRESS
GSLEDIP12			BLK	C1D2		IP66
	<b>CW-</b> Cool White <b>NW-</b> Neutral White <b>WW-</b> Warm White <b>CUS-</b> Custom <i>Contact for custom colour</i>	<b>N-</b> Narrow <b>W-</b> Wide	<b>BLK-</b> Black Anodized	<b>C1D2-</b> Class 1, Div 2 <i>Also available for General Locations                      See GSLEDIP12-GEN-IP66</i>	<b>12VDC-</b> 12 Volts DC <b>24VDC-</b> 24 Volts DC	<b>IP66</b> <b>IP54-</b> See GSLEDIP-C1D2

**TECHNICAL SPECIFICATIONS / MAXIMUM RATINGS**

HOUSING	Type III Hard Anodized Aluminum
MOUNTING	Adjustable Mounting Brackets (Other Options See Pg2)
VOLTAGE MAXIMUM	12VDC: 16 VDC   24VDC: 28 VDC
TYPICAL INPUT VOLTAGE	12VDC: 11-16 VDC   24VDC: 22-28 VDC
POWER	8.4 W
CURRENT	0.66 A @12 VDC   0.33 A @ 24 VDC
CONNECTIONS	6Ft Flying Lead (Custom Lengths Available)
TEMPERATURE RANGE	-40° C to +65° C
TYPICAL CASE TEMPERATURE	~15° C Above Ambient Temperature
CERTIFICATIONS	Certified To CSA 22.2 No. 250.0, Conforms To UL 1598 Standard, Class 1 Division 2 Groups ABCD, T3 Pending - Ex nA IIC T4Gc
INGRESS PROTECTION	IP66 / 67
COLOUR TEMP RANGE	CW: 6500K   NW: 4300K   WW: 3500K
CRI VALUE	CW: 75   NW: 75   WW: 80
TOTAL LUMENS	CW-W: 586   CW-N: 559
LUMEN MAINTENANCE	LM-80 > 60,500 hrs (Based on CREE long term testing)
WEIGHT	1.8 lb   0.8 kg

\*The ambient temperature during lifetime, lumen and chromaticity determination is 25° C ± 1° C

**DIMENSIONS**

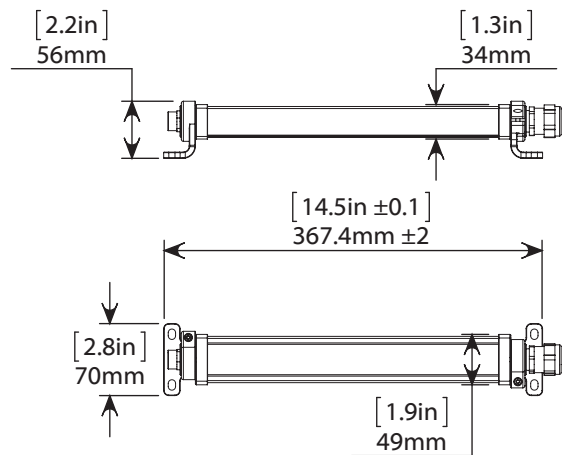

**Alternate Lengths:** (See respective Model Specification Sheets for details)

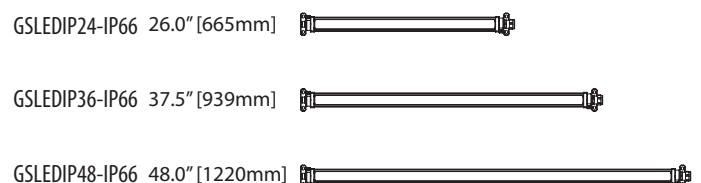

**PHOTOMETRICS**

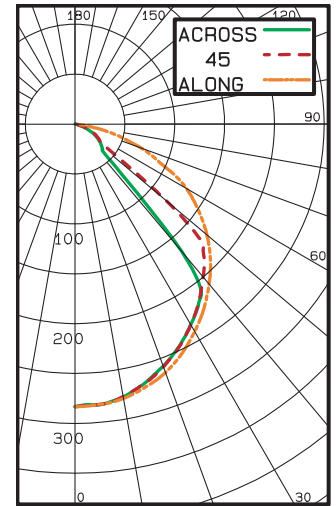
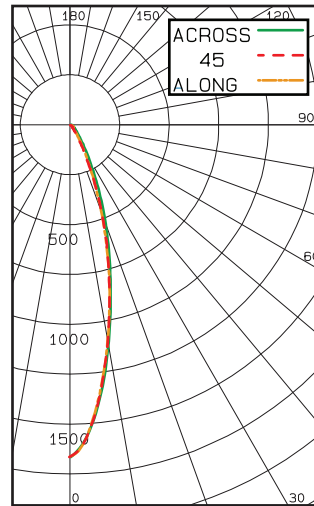
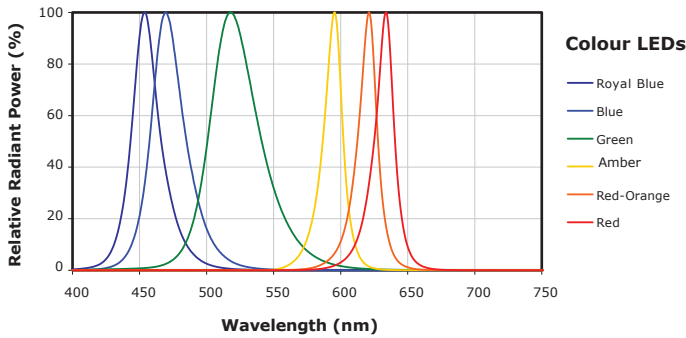
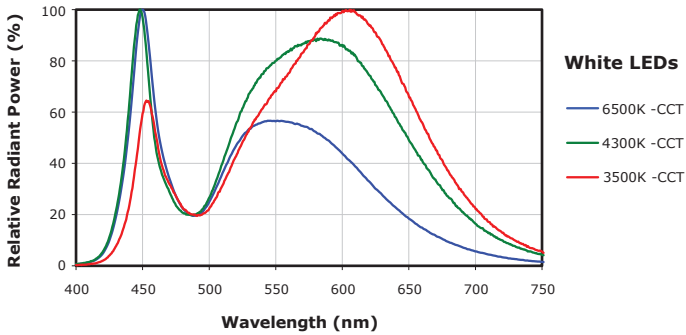

**MOUNTING OPTIONS**

**SURFACE MOUNT**

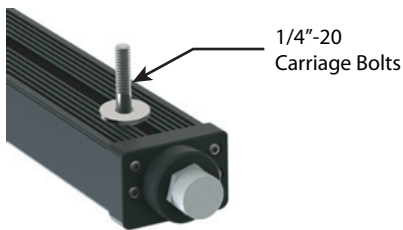

**OPTIC OPTIONS**

**WIDE**



**NARROW**



**CUSTOM OPTIONS**

**WIRING**

Other wire lengths available in 1 foot increments.

**STANDARD ADJUSTABLE MOUNTING BRACKET**

